

- ❑ **Zwischenplatten für vertikale Verkettung**
- ❑ **Auswahlmöglichkeit: Verbindung der Kanäle**
- ❑ **Auswahl Formbohrungen 3/4-16UNF, 7/8-14UNF**
- ❑ **Anschlussmaße gemäß DIN 24 340 / ISO 4401 / CETOP RP121-H**

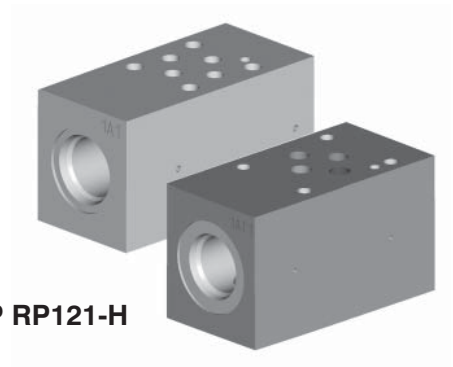



Die Zwischenplatten dienen für den Einbau von 2- und 3-Einschraubwegeventilen in hydraulische Kreisläufe. Die Gusszwischenplatte der Nenngröße Dn 04 gewährleistet eine Montage von einem oder zwei Ventilen mit Gewinde 3/4-16-UNF oder bei der Nenngröße Dn 06 auch mit Gewinde 7/8-14-UNF. Die durchlaufenden Kanäle P, T, A, B in der vertikalen Richtung ermöglichen sog. vertikale Verkettung. Durch die Verkettung der Zwischenplatten in der vertikalen Richtung werden komplizierte hydraulische Steuerkreise

geschaffen. In dem oberen Teil sind die Zwischenplatten mit einer Abdeckplatte oder einem Ventil mit Gehäuse, z.B. mit einem Wegeventil, abgedeckt

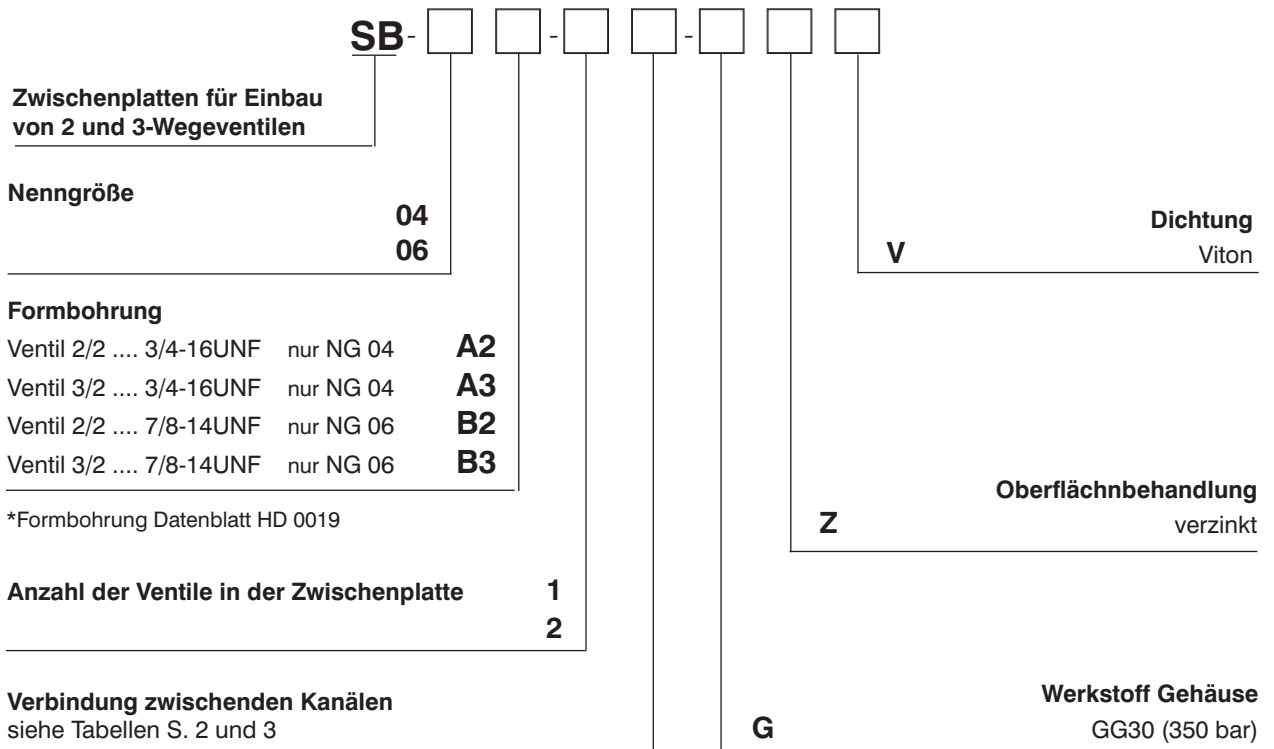
In der Standardausführung sind die Zwischenplatten verzinkt.

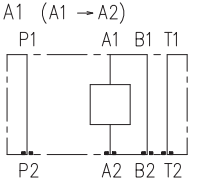
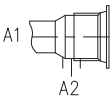
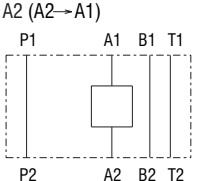
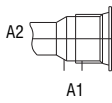
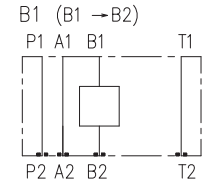
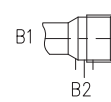
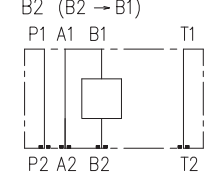
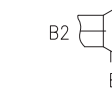
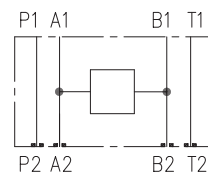
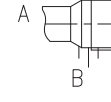
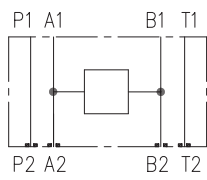
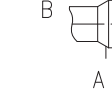
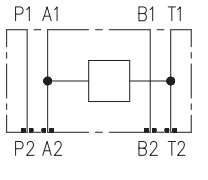
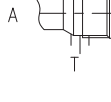
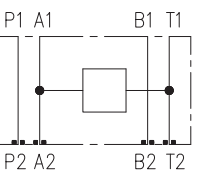

Auswahl: Verbindungen

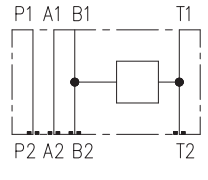
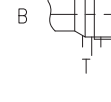
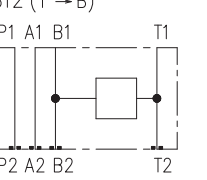
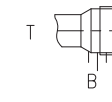
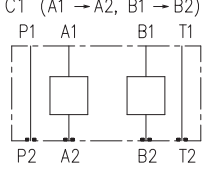
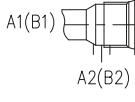
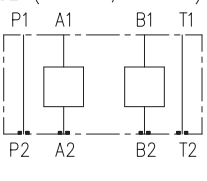
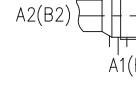
		NG	Form- bohrung	Abmessung
				AxBxC/D
A1 (A1→A2) SB-04A2-1A1-*** SB-06B2-1A1-*** A1 (A1 → A2)  	A2 (A2→A1) SB-04A2-1A2-*** SB-06B2-1A2-*** A2 (A2 → A1)  	04	A2	36x40x74/31,5
		06	B2	45x50x86/30,5
B1 (B1→B2) SB-04A2-1B1-*** SB-06B2-1B1-*** B1 (B1 → B2)  	B2 (B2→B1) SB-04A2-1B2-*** SB-06B2-1B2-*** B2 (B2 → B1)  	04	A2	36x40x74/18,5
		06	B2	45x50x86/12,5
AB1 (A→B) SB-04A2-1AB1-*** SB-06B2-1AB1-*** AB1 (A → B)  	AB2 (B→A) SB-04A2-1AB2-*** SB-06B2-1AB2-*** AB2 (B → A)  	04	A2	36x40x74/31,5
		06	B2	45x50x86/30,5
AT1 (A→T) SB-04A2-1AT1-*** SB-06B2-1AT1-*** AT1 (A → T)  	AT2 (T→A) SB-04A2-1AT2-*** SB-06B2-1AT2-*** AT2 (T → A)  	04	A2	36x40x74/31,5
		06	B2	45x50x86/30,5
BT1 (B→T) SB-04A2-1BT1-*** SB-06B2-1BT1-*** BT1 (B → T)  	BT2 (T→B) SB-04A2-1BT2-*** SB-06B2-1BT2-*** BT2 (T → B)  	04	A2	36x40x74/18,5
		06	B2	45x50x86/12,5
C1 (A1→A2, B1→B2) SB-04A2-2C1-*** SB-06B2-2C1-*** C1 (A1 → A2, B1 → B2)  	C2 (A2→A1, B2→B1) SB-04A2-2C2-*** SB-06B2-2C2-*** C2 (A2 → A1, B2 → B1)  	04	A2	36x40x98/37
		06	B2	45x50x104/30,5

Auswahl: Verbindungen

		NG	Form-bohrung	Abmessung
				AxBxC/D
D1 (A,B → T) SB-04A2-2D1-*** SB-06B2-2D1-*** 	D2 (T → A,B) SB-04A2-2D2-*** SB-06B2-2D2-*** 	04	A2	36x40x98/37
		06	B2	45x50x86/30,5
PT1 (P → T) SB-04A2-1PT1-*** SB-06B2-1PT1-*** 	PT2 (T → P) SB-04A2-1PT2-*** SB-06B2-1PT2-*** 	04	A2	36x40x74/31,5
		06	B2	45x50x86/30,5
P1 (P1 → P2) SB-04A2-1P1-*** SB-06B2-1P1-*** 	P2 (P2 → P1) SB-04A2-1P2-*** SB-06B2-1P2-*** 	04	A2	36x40x74/31,5
		06	B2	45x50x86/30,5
C3 (B1 → A2, A1 → B2) SB-04A2-2C3-*** SB-06B2-2C3-*** 		04	A2	36x40x74/31,5
		06	B2	45x50x104/30,5
1A2 (A1 → A2, T) SB-06A3-1A2-*** SB-06B3-1A2-*** 		06	A3	45x50x73,5/42,5
			B3	45x50x81/25,5
1P2 (P2 → P1, T) SB-06-A3-1P2-*** SB-06-B3-1P2-*** 		06	A3	45x50x98/42,5
			B3	45x50x98/42,5

Zwischenplatten 04 und 06

Zwischenplatten 04 3/4-16UNF

Zwischenplatten 06 7/8-14UNF

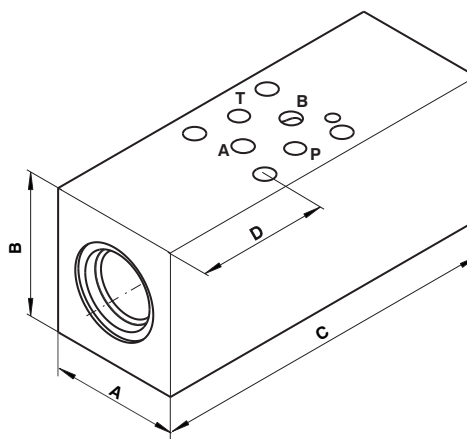

Anschlussmaße gemäß ISO 4401

ISO 4401-02-01-0-05

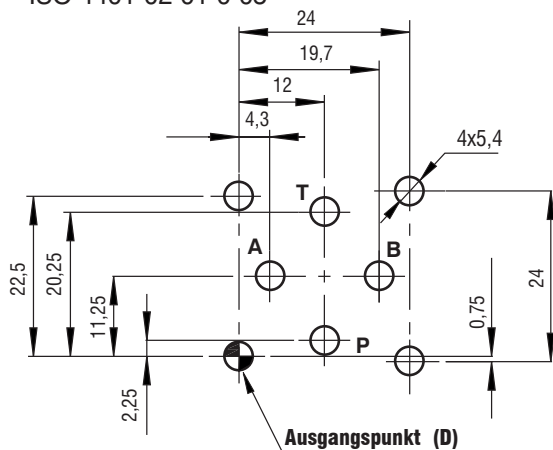

ISO 4401-03-03-0-05

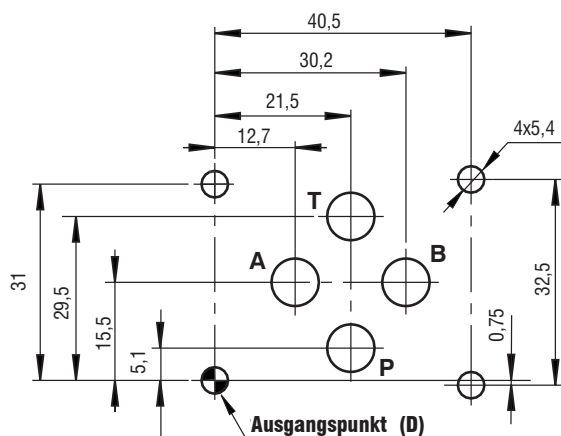

Ersatzteile

Zwischenplatte	Dichtungssatz	Abmessung, Anzahl	Bestellnummer
04	O-Ring	7,5 x 1,8 (4 St.)	29267300
06	O-Ring	9,25 x 1,78 (4 St.)	20152400

Hinweis!

- Die Verpackungsfolie ist recyclingfähig
- Die Transport-Schutzplatte kann zur Entsorgung an uns zurückgesandt werden.
- Die Schrauben für Befestigung der Anschlussplatten werden nicht mitgeliefert.
- Die angegebenen Daten dienen allein der Produktbeschreibung und sind nicht als zugesicherte Eigenschaften im Rechtssinne zu verstehen.

ARGO-HYTOS s.r.o. CZ - 543 15 Vrchlábí
 tel.: +420-499-403 111
 e-mail: info.cz@argo-hytos.com
 www.argo-hytos.com